

Bảng thông số sản phẩm

Thông số kỹ thuật



circuit breaker, EasyPact EZC250F , TMD, 150A ,3 poles 3d

EZC250F3150

Main

Range Of Product	EasyPact
Product Or Component Type	Circuit breaker
Device Short Name	Easypact EZC250F
Circuit Breaker Name	Easypact EZC250F
Device Application	Distribution
Poles Description	3P
Protected Poles Description	3t
Network Type	AC DC
Network Frequency	50/60 Hz
[In] Rated Current	150 A at 40 °C
[Ui] Rated Insulation Voltage	690 V AC 50/60 Hz conforming to IEC 60947-2
[Uimp] Rated Impulse Withstand Voltage	6 kV conforming to IEC 60947-2
[Ue] Rated Operational Voltage	550 V AC 50/60 Hz conforming to IEC 60947-2 250 V DC conforming to IEC 60947-2
Breaking Capacity Code	F
Breaking Capacity	10 kA Icu at 440 V AC 50/60 Hz conforming to IEC 60947-2 15 kA Icu at 400...415 V AC 50/60 Hz conforming to IEC 60947-2 18 kA Icu at 380 V AC 50/60 Hz conforming to IEC 60947-2 25 kA Icu at 110...130 V AC 50/60 Hz conforming to IEC 60947-2 25 kA Icu at 220...240 V AC 50/60 Hz conforming to IEC 60947-2 5 kA Icu at 125 V DC 1P conforming to IEC 60947-2 5 kA Icu at 250 V DC 2P conforming to IEC 60947-2 5 kA Icu at 550 V AC 50/60 Hz conforming to IEC 60947-2
[Ics] Rated Service Breaking Capacity	9 kA at 380 V AC 50/60 Hz conforming to IEC 60947-2 12.5 kA at 110/130 V AC 50/60 Hz conforming to IEC 60947-2 12.5 kA at 220/230/240 V AC 50/60 Hz conforming to IEC 60947-2 2.5 kA at 125 V DC conforming to IEC 60947-2 2.5 kA at 250 V DC conforming to IEC 60947-2 2.5 kA at 550 V AC 50/60 Hz conforming to IEC 60947-2 9 kA at 400/415 V AC 50/60 Hz conforming to IEC 60947-2 7.5 kA at 440 V AC 50/60 Hz conforming to IEC 60947-2
Suitability For Isolation	Yes conforming to IEC 60947-2
Utilisation Category	Category A
Trip Unit Name	TM-D
Trip Unit Technology	Thermal-magnetic
Trip Unit Rating	150 A at 50 °C
Protection Type	Overload protection Short-circuit protection

Pollution Degree	3 conforming to IEC 60664-1 3 conforming to IEC 947-1
-------------------------	--

Complementary

Control Type	Toggle
Mounting Mode	Fixed
Mounting Support	Backplate
Upside Connection	Front
Downside Connection	Front
Mechanical Durability	10000 cycles
Electrical Durability	Category A: 5000 cycles 415 V AC 50/60 Hz conforming to IEC 60947-2
Connection Pitch	35 mm
Local Signalling	Positive contact indication
Neutral Protection Setting	Without protection
Earth-Leakage Protection	Without
Height	165 mm
Width	105 mm
Depth	60 mm

Environment

Standards	GB/T 14048.2 EN/IEC 60947-2 EN/IEC 60947-1
Ip Degree Of Protection	IP20 conforming to IEC 60529
Ik Degree Of Protection	IK07 conforming to IEC 62262
Ambient Air Temperature For Operation	-25...70 °C
Ambient Air Temperature For Storage	-35...85 °C

Packing Units

Unit Type Of Package 1	PCE
Number Of Units In Package 1	1
Package 1 Height	11.4 cm
Package 1 Width	11.3 cm
Package 1 Length	18 cm
Package 1 Weight	1.64 kg
Unit Type Of Package 2	S03
Number Of Units In Package 2	8
Package 2 Height	30 cm
Package 2 Width	30 cm
Package 2 Length	40 cm
Package 2 Weight	13.61 kg

Contractual warranty

Warranty

18 months

Bền vững

Nhãn **Green Premium™** là cam kết của Schneider Electric trong việc cung cấp sản phẩm với hiệu suất môi trường tốt nhất. Green Premium cam kết tuân thủ các quy định mới nhất, minh bạch về tác động môi trường, cũng như các sản phẩm tuần hoàn và CO₂ thấp.

Hướng dẫn đánh giá tính bền vững của sản phẩm là tài liệu kỹ thuật phổ thông giúp làm rõ các tiêu chuẩn nhãn sinh thái toàn cầu và cách diễn giải việc khai báo môi trường.

[Tìm hiểu thêm về Green Premium >](#)

[Hướng dẫn đánh giá về sự bền vững của sản phẩm >](#)



Minh bạch RoHS/REACH

Hiệu suất sức khỏe

Reach Free Of Svhc

Rohs Exemption Information Yes

Chứng nhận & Tiêu chuẩn

Reach Regulation

[REACH Declaration](#)

Eu Rohs Directive

Compliant with Exemptions

Environmental Disclosure

[Product Environmental Profile](#)

Weee

The product must be disposed on European Union markets following specific waste collection and never end up in rubbish bins

Circularity Profile

No need of specific recycling operations

Bảng thông số sản phẩm

EZC250F3150

Dimensions Drawings

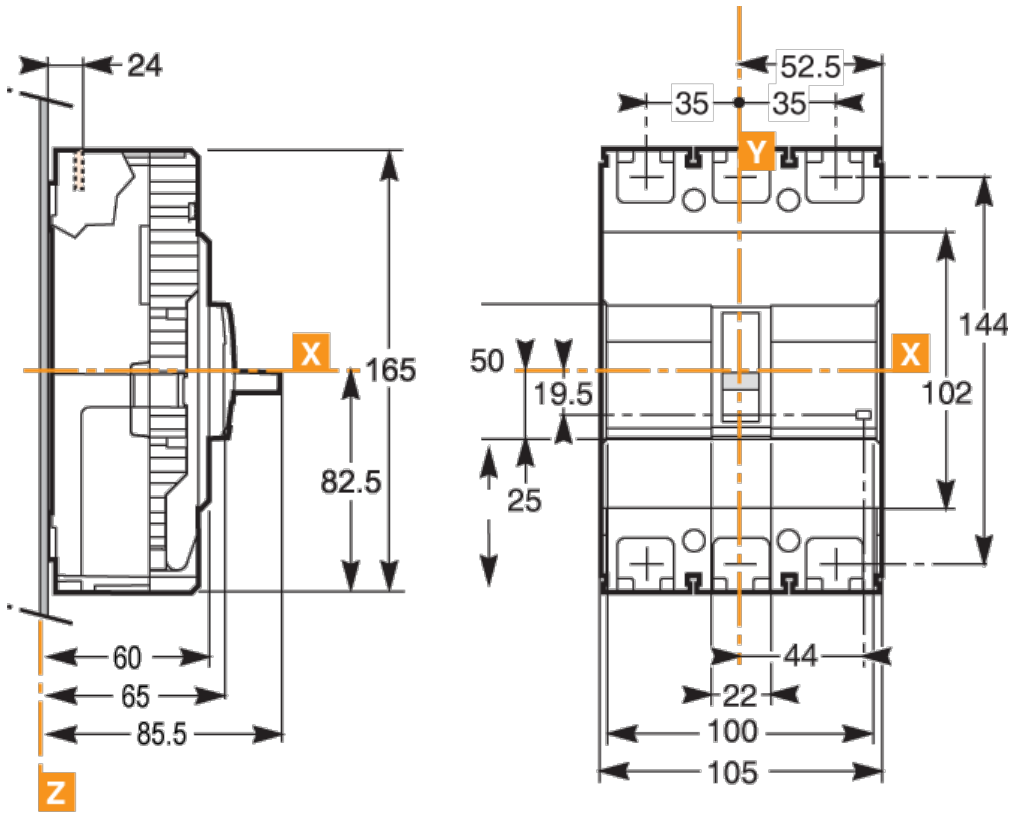

Assembly

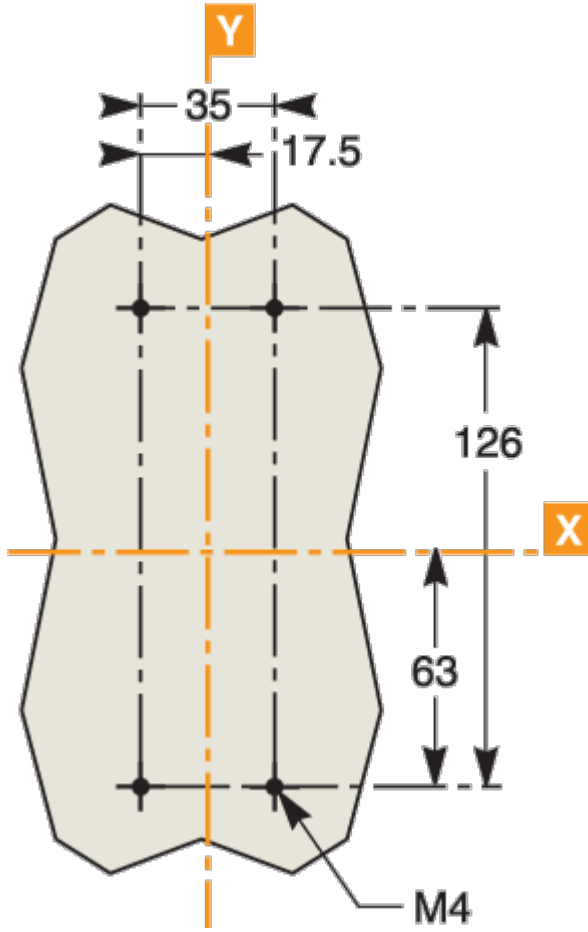

Performance Curves

