

New Digital

New digital



Model	3DM2/ FDM2	3MZ2/ FMZ2	
Control voltage	AC/DC 100 ~ 240V	AC/DC 100~240V	
Frequency	DC/AC 24V	DC/AC 24V	
Single phase	50/60 Hz	50/60 Hz	
Three phase	●	●	
CT type	Window hole	●	
	Bottom hole	●	
	Terminal	●	
	Overcurrent	●	
	Undercurrent	●	
	Stall	●	
	Jam	●	
Protection	Phase loss	●	
function	Phase reversal	●	
	Imbalance	●	
	Ground fault	-	●
	Short circuit	-	-
	Thermal inverse	-	-
4-20mA output	-	-	
Additional function	Alert output	A, F, H	-
	Bar graph	●	●
	Display	5 Digit 7 Segment	5 Digit 7 Segment
	Password function	-	-
	Fail safe ON/OFF	●	●
	Trip cause display and Store	●	●
	Total running hour	●	●
	Running hour timer	●	-
Reset	Manual/Auto/Electric	Manual/Auto/Electric	
Comm. protocol	-	-	
Existing model	3DD, 3DE, 3DM	3DZ, 3EZ, 3MZ	
	FD, FDE, FDM	FDZ, FEZ, FMZ	

New Digital

Selection guide

Old model	Measurement method	Operation TCC	Reset	Mounting	Protections function			Additional function		New model
3DD	3CT	Definite TCC • Inverse TCC	Manual	Panel • Din-Rail	Overcurrent, Phase loss, Phase reversal, Lock rotor, Imbalance	–	–	Alert	Trip cause display	3DM2 or i3DM
3DE			Manual			Under current			Trip cause display-store the latest three histories.	
3DM			Manual Auto			–			Bar graph, Running hour timer, Trip cause display-store the latest three histories.	
FD			Manual	Panel Din-Rail Flush Mount		–			Bar graph, Trip cause display	FDM2 or iFDM
FDE			Manual			Under current			Bar graph, Trip cause display-store the latest three histories.	
FDM			Manual Auto			–			Bar graph, Running hour timer, Trip cause display-store the latest three histories.	
3DZ	3CT	Definite TCC • Inverse TCC	Manual	Panel Din-Rail	Overcurrent, Phase loss, Phase reversal, Lock rotor, Imbalance	–	Ground Fault	–	Trip cause display	3MZ2 or i3MZ
3EZ			Manual			Under current			Trip cause display-store the latest three histories.	
3MZ			Manual Auto			–			Bar graph, Running hour timer, Trip cause display-store the latest three histories.	
FDZ			Manual	Panel Din-Rail Flush Mount		–			Bar graph, Trip cause display	FMZ2 or iFMZ
FEZ			Manual			Under current			Bar graph, Trip cause display-store the latest three histories.	
FMZ			Manual Auto			–			Bar graph, Running hour timer, Trip cause display-store the latest three histories.	
3D420	3CT	Definite TCC • Inverse TCC	Manual	Panel Din-Rail	Overcurrent, Phase loss, Phase reversal, Lock rotor, Imbalance	–	–	–	Trip cause display	i3M420
3E420			Manual			Under current			Trip cause display-store the latest three histories.	
3M420			Manual Auto			–			Bar graph, Running hour timer, Trip cause display-store the latest three histories.	
FD420			Manual	Panel Din-Rail Flush Mount		–			Bar graph, Trip cause display	iFM420
FE420			Manual			Under current			Bar graph, Trip cause display-store the latest three histories.	
FM420			Manual Auto			–			Bar graph, Running hour timer, Trip cause display-store the latest three histories.	
3DS	3CT	Definite TCC • Inverse TCC	Manual	Panel Din-Rail	Overcurrent, Phase loss, Phase reversal, Lock rotor, Imbalance	–	Short circuit	–	Bar graph, Trip cause display	i3MS
3MS			Manual Auto			Under current			Bar graph, Running hour timer, Trip cause display-store the latest three histories.	
FDS			Manual	Panel Din-Rail Flush Mount		–			Bar graph, Trip cause display	iFMS
FMS			Manual Auto			Under current			Bar graph, Running hour timer, Trip cause display-store the latest three histories.	

Selection guide

Old reference	New reference	Display	Cable	Option
				ZCT
3DD-05DB, 3DD-60DB, 3DE-WRDB, 3DM-WRDB	3DM2-WRDBW(T)	-	-	-
	3DM2-WRDBH(T)	-	-	-
3DD-05DZ7, 3DD-60DZ7, 3DE-WRZF7, 3DE-WRDZ7, 3DMWRDZ7	3DM2-WRDUW	-	-	-
	3DM2-WRDUH	-	-	-
FD-05DBW(T), FD-60DBW(T), FDE-WRDBW(T), FDMWRDBW(T)	FDM2-WRDBW	EOCR-PDM	CABLE-RJ45-xxx	-
	FDM2-WRDBH	EOCR-PDM	CABLE-RJ45-xxx	-
FD-05DZ7W(T), FD-60DZ7W(T), FDE-WRDF7W(T), FDMWDZ7W(T), 3DM-WDZ7W(T)	FDM2-WRDUW	EOCR-PDM	CABLE-RJ45-xxx	-
	FDM2-WRDUH	EOCR-PDM	CABLE-RJ45-xxx	-
3DZ-05ABA(B), 3DZ-60ABA(B), 3EZ-WRABA, 3MZWRABA(B)	3MZ2-WRABW	-	-	ZCT-xxx
	3MZ2-WRABH	-	-	ZCT-xxx
3DZ-05CBA(B), 3DZ-60CBA(B), 3MZ-WRCBA(B)	3MZ2-WRCBW	-	-	ZCT-xxx
	3MZ2-WRCBH	-	-	ZCT-xxx
3DZ-05AZ7A(B), 3DZ-60AZ7A(B), 3EZ-WRAF7A, 3EZ-WRAM7A, 3MZ-WRAZ7W(T)A(B)	3MZ2-WRDBW	-	-	ZCT-xxx
	3MZ2-WRDBH	-	-	ZCT-xxx
3DZ-05CZ7A(B), 3DZ-60CZ7A(B), 3MZ-WRCZ7W(T)A(B)	3MZ2-WRAUW	-	-	ZCT-xxx
	3MZ2-WRAUH	-	-	ZCT-xxx
3DZ-05DBA(B), 3DZ-60DBA(B), 3MZ-WRDBA(B)	3MZ2-WRCUW	-	-	ZCT-xxx
	3MZ2-WRCUH	-	-	ZCT-xxx
3DZ-05DZ7A(B), 3DZ-60DZ7A(B), 3MZ-WRDZ7W(T)A(B)	3MZ2-WRDUW	-	-	ZCT-xxx
	3MZ2-WRDUH	-	-	ZCT-xxx
FDZ-05ABW(T)A(B), FDZ-60ABW(T)A(B), FEZ-WRABW(T)A, FMZ-WRABW(T)A(B)	FMZ2-WRABW	EOCR-PDM	CABLE-RJ45-xxx	ZCT-xxx
	FMZ2-WRABH	EOCR-PDM	CABLE-RJ45-xxx	ZCT-xxx
FDZ-05CBW(T)A(B), FDZ-60CBW(T)A(B), FMZWRCBW(T)A(B)	FMZ2-WRCBW	EOCR-PDM	CABLE-RJ45-xxx	ZCT-xxx
	FMZ2-WRCBH	EOCR-PDM	CABLE-RJ45-xxx	ZCT-xxx
FDZ-05DBW(T)A(B), FDZ-60DBW(T)A(B), FMZWRCBW(T)A(B)	FMZ2-WRDBW	EOCR-PDM	CABLE-RJ45-xxx	ZCT-xxx
	FMZ2-WRDBH	EOCR-PDM	CABLE-RJ45-xxx	ZCT-xxx
FDZ-05AZ7W(T)A(B), 3DZ-60AZ7W(T)A(B), FEZWRAF7W(T)A, 3EZ-WRAM7W(T)A, 3MZ-WRABW(T)A(B)	FMZ2-WRAUW	EOCR-PDM	CABLE-RJ45-xxx	ZCT-xxx
	FMZ2-WRAUH	EOCR-PDM	CABLE-RJ45-xxx	ZCT-xxx
FDZ-05CZ7W(T)A(B), 3DZ-60CZ7W(T)A(B), FMZWRCZ7W(T)A(B)	FMZ2-WRCUW	EOCR-PDM	CABLE-RJ45-xxx	ZCT-xxx
	FMZ2-WRCUH	EOCR-PDM	CABLE-RJ45-xxx	ZCT-xxx
FDZ-05DZ7W(T)A(B), 3DZ-60DZ7W(T)A(B), FMZWRCZ7W(T)A(B)	FMZ2-WRDUW	EOCR-PDM	CABLE-RJ45-xxx	ZCT-xxx
	FMZ2-WRDUH	EOCR-PDM	CABLE-RJ45-xxx	ZCT-xxx
3D420-059, 3D420-609, 3E420-WR9, 3M420-WR9	i3M420-WRDBW	-	-	-
	i3M420-WRDBH	-	-	-
3D420-053, 3D420-603, 3D420-056, 3D420-606, 3E420-WR91, 3M320-WR3, 3M420-WR6	i3M420-WRDUW	-	-	-
	i3M420-WRDUH	-	-	-
FD420-0539, FD420-6039, FD420-0569, FD420-6069, FE420-WR91(3), FM420-WR91(3)	iFM420-WRDBW	EOCR-PDM	CABLE-RJ45-xxx	-
	iFM420-WRDBH	EOCR-PDM	CABLE-RJ45-xxx	-
FD420-0531(3), FD420-6031(3), FD420-0561(3), FD420-6061(3), FE420-WR3(1), FE420-WR6(1), FM420-WR31(3), FM420-WR61(3)	iFM420-WRDUW	EOCR-PDM	CABLE-RJ45-xxx	-
	iFM420-WRDUH	EOCR-PDM	CABLE-RJ45-xxx	-
3DS-05DB, 3DS-20DB, 3MS-05DB, 3MS-20DB	i3MS-WRDBW	-	-	-
	i3MS-WRDBH	-	-	-
3DS-05DZ7, 3DS-20DZ7, 3MS-05DZ7, 3MS-20DZ7	i3MS-WRDUW	-	-	-
	i3MS-WRDUH	-	-	-
FDS-05DBW(T), FDS-20DBW(T), FMS-05DBW(T), FMS-20DBW(T)	iFMS-WRDBW	EOCR-PDM	CABLE-RJ45-xxx	-
	iFMS-WRDUH	EOCR-PDM	CABLE-RJ45-xxx	-
FDS-05DZ7W(T), FDS-20DZ7W(T), FMS-05DZ7W(T), FMS-20DZ7W(T)	iFMS-WRDBW	EOCR-PDM	CABLE-RJ45-xxx	-
	iFMS-WRDUH	EOCR-PDM	CABLE-RJ45-xxx	-

EOCR-i Series (with communication)

Basic model : EOCR-i3DM (Z, S, 420) / iFDM (Z, S, 420)

EOCR-i3DM Window type



EOCR-i3DM Bottom hole type



EOCR-iFDM Window type



EOCR-iFDM Bottom hole type



EOCR-i3DM Terminal type



EOCR-iFDM Terminal type



General features

- Micro-Controller Unit based
- Real time processing / High precision
- Protections : Over current, Under current, Phase loss, Phase reversal, Stall, Jam, Current imbalance, Earth fault (i3MZ/iFMZ), Short circuit (i3MS/iFMS)
- **Thermal protection** / Inverse available up to 32Amps without external CTs.
- Auxiliary functions : Fail safe, Pre-alarm (i3DM/iFDM), Accumulated running hour, 3 fault records & limitation of auto-restart. Analog output (i3M420/iFM420).
- **Communication : Modbus / RS-485**
- Reinforced monitoring function : Monitoring distance up to 400M, 3 phase current display, Pre-alarm (i3DM/iFDM) & Trip cause indication
- Bar graph indication of a load current to the current setting.
- Available application on single and 3 phase motor
- RoHS Compliance
- For iFDM/iFMZ/iFMS/iFM420, normal protections are guaranteed even if PDM is disconnected.

EOCR-i Series (with communication)

Basic model : EOCR-i3DM (Z, S, 420) / iFDM (Z, S, 420)

Protection functions

Protection item	Condition & Setting range	Operation time
Over current (oc)	Condition : Load current (In) exceeds setting current (Is) Setting range : 0.5~60A (Def), 0.5~32A (Inv & th)	Definite (Def) : 0.2~30s Adjust. Inverse (Inv) & Thermal (th) : 1~30 class
Under current (uc)	Condition : Load current (In) less than setting current $In \leq uc$ uc should be less than oc setting	oFF, 1~10s Adjustable
Phase loss (PL)	Condition : max imbalance is more than 85% among 3 phase current, Enable or disable : Selectable	oFF, 0.5~5s Adjustable
Reverse phase (RP)	Condition : Reversed phase sequence input on EOCR. Enable or disable : Selectable	Within 0.15s
Stall (Sc)	Condition : $In \geq$ Stall current setting (Sc). Active only in motor starting 0.5~30A : 2~8 times of oc setting ~40A : 2~6 times, ~60A : 2~4 times.	Right after D-time elapsed
Jam (JA)	Condition : $In \geq$ Jam current setting (JA). Active only in motor running 0.5~50A : 1.5~5 times of oc setting ~60A : 1.5~4 times of oc setting	0.2~5s Adjustable
Imbalance (IM)	Condition : Current imbalance \geq Setting imbalance % Setting range : 10~50% of imbalance	1~10s Adjustable
Earth fault (EF)	Condition : EF current (Ie) exceeds setting current (Ies) OFF, 0.03~10A	0.05~5s Adjustable -- i3MZ/iFMZ only --
Short circuit (SH)	Condition : SC current (Is) exceeds setting current (Iss) 0.5~10A : 2~22 times of oc setting, ~20A : 2~11 times of oc setting	0.05sec -- i3MS/iFMS only --

Auxiliary functions

Password	For secured setting parameters
Communication	Monitoring currents and trip status by network
Phase selection	For single phase / three phase motor selection
TCC selection	Available three time-current-characteristics (Definite, Inverse, Thermal inverse)
CT ratio	For the current setting more than 60A (20A : i3MS/iFMS) and less than 0.5A
Fail safe selection	Fail safe operation for OL trip output
Pre alarm selection	Pre alarm signaling by the 07-08 output contact -- i3MS/iFDM only --
Total running hour	Total accumulated running hour from the installation which cannot be modified and reset.
Running hour	Display or provided a time-out signal to the 07-08 output contact. -- i3MS/iFDM only --
Reset mode	Manual / Auto / Electrical ; selectable
Trip cause memory	Store the latest 3 trip causes
Restart limitation	The maximum auto-restart number within 30 minutes in auto-reset mode.

EOCR-i Series (with communication)

Basic model : EOCR-i3DM (Z, S, 420) / iFDM (Z, S, 420)

Specifications

Model		i3DM / iFDM, i3MZ/iFMZ, i3MS/iFMS, i3M420/iFM420	
Over current	Rated setting range (A)	Definite TCC : 0.5~60A. : use external CT higher than 60A	
		i3MS/iFMS : 0.5~20A : use external CT higher than 20A	
		Inverse & th TCC : 0.5~32A. use external CT higher than 32A	
Under current	Rated setting range (A)	0.5A ~ less than oc setting	
Operating time characteristics		Definite(Def) / Inverse(Inv) / Thermal(th)	
Time setting	Def	D-time	0~200s
		O-time	0.2~30s
	Inv & th (cLS)		1~30 classes
	GF delay time (Edt)		0~30s (i3MZ/iFMZ)
	GF O-time (Et)		0.05~10s (i3MZ/iFMZ)
	SH delay time (SHd)		0~30s (i3MS/iFMS)
	SH O-time		Within 0.05s fixed (i3MS/iFMS)
	Auto-reset		0.5s~20min.
	Reset mode		Manual reset (H-r) / Electric reset (E-r) / Auto-reset (A-r)
	Control power	Voltage	
Frequency		50/60Hz	
Power consumption		Lower than 7VA	
Output	Capacity		3A/250VAC resistive.
	Composition		1a1b : OC (i3DM/iFDM, i3MS/iFMS, i3M420/iFM420) 1a : GR (i3MZ/iFMZ), or AL (i3DM/iFDM), or SH (i3MS/iFMS)
Display	7 Segment LED		3 phase amps, Cause of trip, Setting parameters indication.
	Bar graph		Load factor.
Communication		Modbus/ RS-485	
Mounting	Panel mounting (i3DM/i3MZ/i3MS/i3M420)		
	Flush mounting (iFDM/iFMZ/iFMS/iFM420)		
Insulation	Between case & Circuit	Over DC500V 10MΩ	
Dielectric strength	Between case & Circuit	2kV, 50/60Hz, 1 Min.	
	Between contacts	1kV, 50/60Hz, 1 Min.	
	Between circuit	2kV, 50/60Hz, 1 Min	
Electrostatic discharge (ESD)	IEC61000-4-2	Level 3 : Air discharge : ±8KV, Contact discharge : ±6KV	
Radiated disturbance	IEC61000-4-3	Level 3 : 10V/m, 80 ~ 1000MHz	
Conducted disturbance	IEC61000-4-6	Level 3 : 10V,0.15~80MHz	
EFT/Burst	IEC61000-4-4	Level 3 : ±2KV, 1 Min	
Surge	IEC61000-4-5	Level 3 : 1.2 x 50µs, ±4KV (0°, 90°, 180°, 270°)	
Emission	CISPR11	Class A (Conducted and radiated)	
Environment	Temperature	Store	-40°C ~ +85°C
		Operation	20°C ~ +60°C
	Humidity	30~85% RH (Non-condensate)	
Dimension	Window type	70W x 74.5H x 83.8D	
	Bottom hole type	70W x 56.3H x 108.1D	
Weight		i3DM / i3MZ / i3MS / i3M420	iFDM / iFMZ / iFMS / iFM420
	Window type	330g	420g
	Bottom hole type	370g	460g
	Terminal type	370 + 120(PDM) = 490g	460 + 120(PDM) = 580g
	Display (W/3M cable)	-	125g
Power consumption		Less than 7VA.	

EOCR-i Series (with communication)

Basic model : EOCR-i3DM (Z, S, 420) / iFDM (Z, S, 420)

Front face

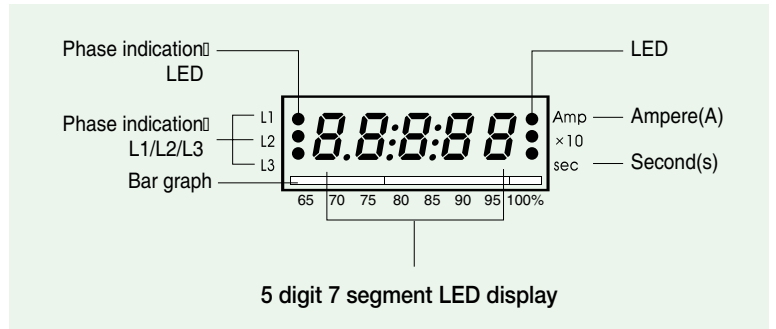
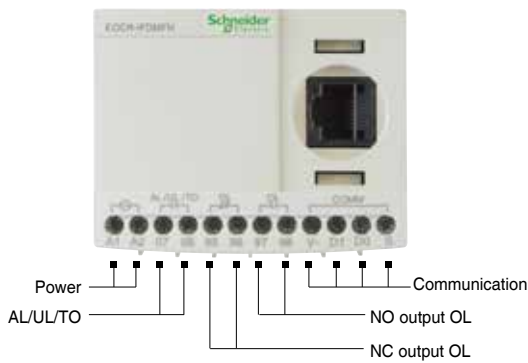
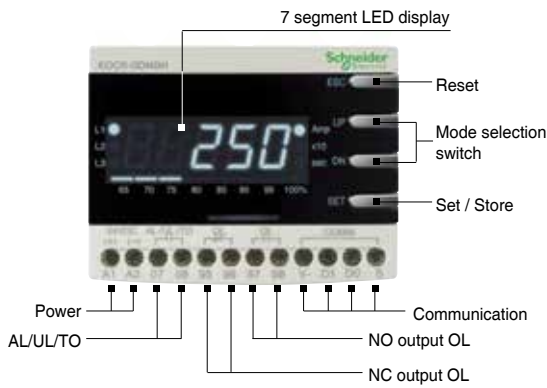

3 phase load currents (In) and a leakage current (i3MZ/iFMZ) are displayed every 2 seconds in sequence.

Bar graph

- it shows the load factor to OC setting value by %
- % value = (running current/setting current) * 100%
- Min scale is 65%
- if the setting value is the rated motor current, it shows the load factor of the motor.

Current Display

- Shows the highest current among three phases for OC, Stall, Jam trips.
- Shows the lowest current among three phases for UC, UB
- Shows the lost phase for PL.
- Shows the phase and the current during running.

Amp : Ampere. LED is on when a current display.

x 10 : Shows the unit changed to 10 times.

Sec : Second. LED is on when a time display.

EOCR-i Series (with communication)

Basic model : EOCR-i3DM (Z, S, 420) / iFDM (Z, S, 420)

3 phase digital ammeter function

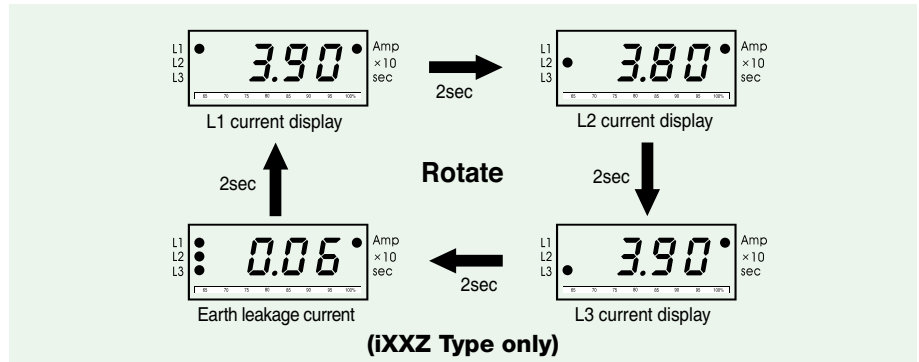

* Blocking display rotation can be done by pressing the SET button once during running. whenever press the SET button, the each phase current displays by turns. A fixed phase current display can be done by this.
 * Pressing the ESC button, it returns to the Auto current display rotation mode.

Buttons and setting sequence

Button Display	Function
▲ UP ▼ DN	Press the UP or DN button to find the menu you want to set. For menus, see the descriptions on setting sequence and display.
SET	Press the SET button once to send a signal to the relay that notifies it that the setting process will begin. Then, the number or characters you want to set will start to flicker. This indicates that you can now change the setting.
▲ UP ▼ DN	Press the UP or DN button to find the number or characters you want to set.
SET	If the characters or number you want to set is displayed, press the SET button for the relay to save it. The character or number then stops flickering. This indicates that the setting has been saved.
ESC	Press the ESC button to return to the current display. If you do not press ESC button for over 50 seconds after the setting is made, it will automatically return to the current display.

* Fault History View: In Fault History View mode, you can check the fault history, from the most recent fault to the oldest fault. While checking the history, the most recent fault cause, fault current, and fault phase will be displayed. Every time you press the DN button, the values for L1, L2, L3, (earth fault current), L1-L2, L2-L3, L3-L1 will be displayed, in this order. To check the previous fault history, press the DN button again. While the fault history is being displayed, a bar graph will show the display info of the most recent fault only on the 100% LED. The display info of the next-most-recent fault will be displayed on the two LEDs of 95% and 100%, and for the third-most-recent fault info, all three LEDs of 90%, 95%, and 100% will show the fault info. If you press ESC briefly while viewing the fault history, it will switch to the circulation display of current and voltage. If you press the UP or DN button, among the LEDs of L1, L2, and L3 on the left side, the LED of the corresponding phase will display the fault current on the left side. For all other displays, the fault item info will be displayed as well. The history of up to 3 faults is saved, with the oldest history overwritten by a new fault when it occurs.

• Setting sequence

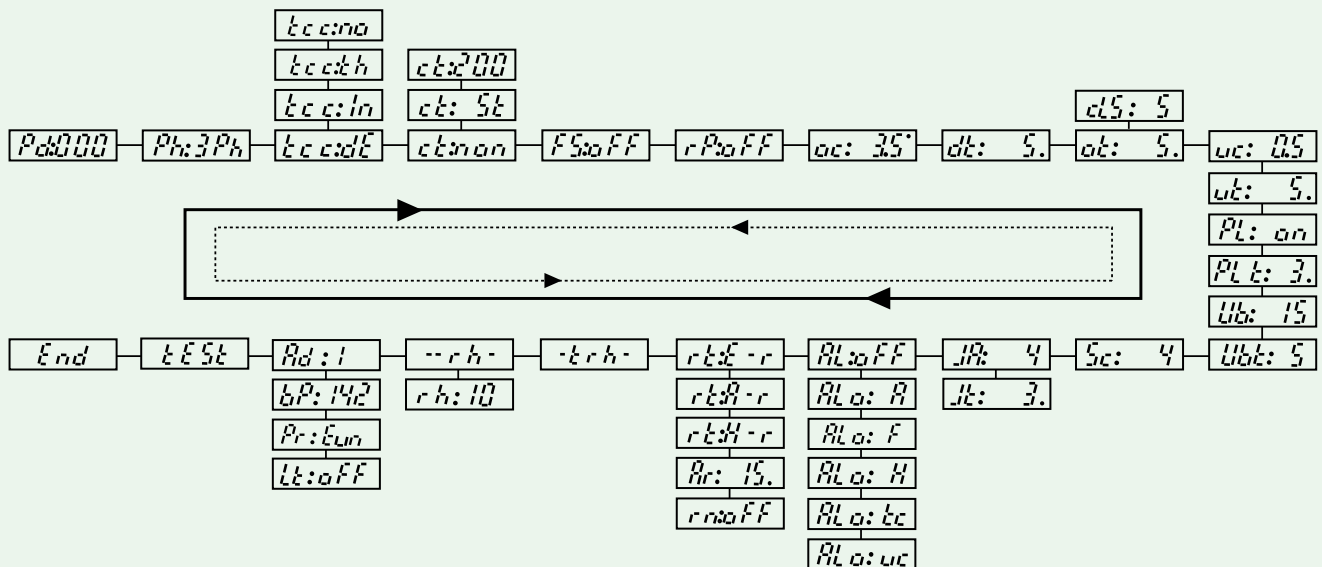

EOCR-i Series (with communication)

Basic model : EOCR-i3DM (Z, S, 420) / iFDM (Z, S, 420)

Setting sequence and menu

No.	Menu	Parameter	Description	Default
1	Password	Pd:000	Use password other than zero for secured settings. This feature enables limitation of setting modification by unauthorized person. Zero value is used for disabling password checking.	Pd:000
2	Selection of Phase No.	Ph: 3Ph Ph: 1Ph	"Ph:3Ph" mode for a 3 phase load, "Ph:1Ph" mode for a 1 phase load should be selected. If you select the "Ph:1Ph", RP, PL and Ub functions will be disabled and not displayed in the menu mode	Ph: 3Ph
3	3 Operation curve	tcc:dE tcc:In tcc:th tcc:no	Time-current characteristic(TCC) setting. "dE" is for definite TCC, "In" is for inverse TCC, "th" is for thermal Inverse TCC. Refer to the time-current characteristic curve. If tcc=no, only overcurrent protection is disabled	tcc:dE
4	CT ratio	ct:non ct:200 ct:2t ct:800 ct:5t	External CT ratio setting mode. This is applied to definite TCC; higher than 60A and inverse TCC; higher than 32A. Set the primary value of the external CT. For example, 200:5 CT, setting is "ct:200". For the low-range current "ct: 2t" is for 2 pass through, "ct: 5t" is for 5 pass through. Select "ct:non" in case of no external CT and no loop.	ct:non
5	Frequency	Fr 9.60 Fr 9.50	Frequency setting mode. Select 50 or 60 based on the system fundamental frequency.	Fr 9.60
6	Fail safe	FS: on FS:oFF	Selection of fail safe(No volt release) mode for overload trip output, OL. Refer to fail-safe operation	FS:oFF
7	Reversed phase detection	rP: on rP:oFF	Enable or disable reverse phase detection	rP:oFF
8	Over current threshold	oc: 3.5	Threshold for over current protection . this value cannot be set below the under current threshold (uc).	oc: 5.0
9	Start delay time	dt: 5.	Motor starting delay, OC, UC, Stall, Jam, Ub are blocked during starting but PL, RP are not blocked. For "In" TCC mode , the cold curve is applied before dt expires and, the hot curve is applied after dt expires.	dt: 5.
10	Over current duration (Trip delay time / Trip class)	ot: 5.	(tcc:dE) ; the fault(over current) duration of definite overcurrent protection. (tcc:In) ; the trip class for inverse overcurrent protection(refer to TCC curve) (tcc:th) ; the thermal overload protection based on the thermal image by load current (refer to TCC curve).	ot: 5.
11	Under current threshold	uc: 0.5	Threshold for under current protection. The setting should be higher than no-load current of a motor. The current value cannot be set higher than OC.	uc:oFF
12	Under current duration (Trip delay time)	ut: 5.	Fault (under current) duration for the under current Operation. If the setting of "oFF" in the "uc" mode is selected, this menu is not displayed	ut: 5.
13	Earth fault (Ground fault) threshold	Ec:0.05	Threshold for earth fault protection. The capacitance leakage current of the motor and cable should be taken into account for the setting. The threshold value corresponds to the primary current of ZCT	Ec: 0.5
14	Earth fault trip delay time	Et:0.05	Earth fault duration (Trip delay time) TCC is definite characteristic	Et:1.
15	EF starting delay	Ede: 6.	Blocking time of Earth Fault detection during motor starting. OFF, 1~30s adjustable This timer is only active during motor starting.	Ede: 0.
16	Short circuit current threshold	SH: 12	Threshold for short circuit detection. This value is the multiples of the over current threshold (oc). The SC fault duration is fixed to 0.05 second.	SH: 10

EOCR-i Series (with communication)

Basic model : EOCR-i3DM (Z, S, 420) / iFDM (Z, S, 420)

Setting sequence and menu

No.	Menu	Parameter	Description	Default
17	SC starting delay	SHd: 7.	Blocking time of short circuit detection during motor starting. This timer is only active during motor starting.	SHd: 0.
18	Phase loss	PL: on PL:off	Enable or disable phase loss(Single phasing) detection. If the "Ph:1Ph" is selected, this menu is not displayed.	PL: on
19	Phase loss time	PLt: 3.	Fault duration for phase loss operation. The setting range is 0.5-5 sec. if "PL:off" is selected, this menu is not displayed	PLt: 3.
20	Imbalance threshold	Ub: 15	Threshold for current imbalance operation. To disable the function, set to "oFF", the setting range is 10-50%. Imbalance factor (%) = $(I_{max\ phase} - I_{min\ phase}) / I_{max\ phase} \times 100\%$	Ub: 15
21	Imbalance fault duration	Ubt: 5	Imbalance fault duration (trip delay time) for current imbalance operation. The setting range is 1-10 seconds.	Ubt: 5
22	Stall threshold	Sc: 4	Threshold for locked rotor detection during motor starting. The value is the multiples of the over current threshold(oc). If the locked rotor condition is detected, the trip relay operates in 0.5s after the "dt" expires. If dt=0, this function is disabled and not displayed in the menu. Setting range : oc=0.4-30A:2-8times, oc < 40A:2-6times, otherwise (oc<60A) : 2-4times, (with Ext. CT : 2-8times)	Sc: 4
23	Jam threshold	Jr: 4	Threshold for locked rotor detection during motor running. The value is the multiples of the over current threshold (oc). Setting : oc=0.4-50A : 1.5-5times, otherwise (oc<60A) : 4times, (with Ext. CT : 15-5times)	Jr: 4
24	Jam fault duration	Jt: 3.	Jam fault duration (trip delay time) Setting : 0.2-10 sec	Jt: 3.
25	420 Output range		Reference value for max analog output (20mA) If the load current is equal or greater than this value, analog output is fixed to 20mA	
26	Alert	rS: 5.0*	Threshold of Alert output, set by % of the over current threshold (oc). If the load current is higher than this value, alert output(07-08 contact) is energized according to the setting of "ALo : XX".	rS: 5.0*
		AL: 85 AL:off	If the load current is detected, alert output(07-08 contact) is energized. The alert threshold is no meaning for this operation. Refer to the alert operation pattern.	
		ALo: A	If the load current is higher than the alert threshold, alert output(07-08 contact) repeats open for 1s and close for 1s (flickering), The flickering starts from the motor starting. Refer to the alert operation pattern.	
		ALo: F	If the load current is higher than the alert threshold, alert output(07-08 contact) is closed (holding) and remains closed until the load current decrease under the alert threshold. The alert output is blocked during motor starting. Refer to the alert operation pattern.	
		ALo: H	If the accumulated running hour is more than the running hour threshold, the alert output repeats close for 1s and open for 1s.	
		ALo:to	The alert output is used only for under current protection. If this mode is selected, a trip by an under current fault is signaled through alert output (07-08), instead of overload trip output(95-96 or 97-98).	

EOCR-i Series (with communication)

Basic model : EOCR-i3DM (Z, S, 420) / iFDM (Z, S, 420)

Setting sequence and menu

No.	Menu	Parameter	Description	Default
27	Reset		Fault reset (Electrical reset) by a power cycle or by pressing the ESC button.	
			Fault reset (Hand reset) by only pressing the ESC button.	
		 	Fault reset (Auto Reset) by a auto-reset timer, Setting range of the timer : 0.5sec~20min. Also the fault can be reset by power cycle or by ESC button. The relay cannot be reset automatically when the relay is tripped by Phase Reversal(rP), Phase Loss(PL), Stall(Sc) and Jam(JA)	
28	Restart limitation		The maximum auto-restart number during 30 minutes in auto-reset mode. The auto-restart counter (count) is stored in the non-volatile memory and is cleared by pressing ESC button when the counter(count) reaches the limitation. To disable limitation, select "oFF". Setting range : oFF~5 times.	
29	Total running hour	 	In this menu, toggle display, "-trh-" and the accumulated (time) value, is activated (?) The accumulation starts from the installation and the user cannot clear the accumulated value. This display unit is 1 hour.	read only
30	Running hour	 	In this menu, toggle display, "--rh-" and the accumulated value, is activated (?) The user can clear the accumulated value by selecting the running hour threshold to "rh:oFF". This display unit is 0.1 hour (6 minutes). By selecting "ALo:to", the user can get the alert signal through alert output (07-08) when the accumulated value is more than the running hour threshold.	read only
31	Running hour threshold		Threshold for alert output when the user selects "ALo:to". The unit is 10 hours and this menu is not displayed when the motor is starting or running. Setting range : 10~9990 hours, oFF	
32	Communication		Modbus slave (ID) address. Range : 1 ~ 247.	
		 	Setting for communication speed Range : 1.2kbps, 2.4Kbps, 4.8Kbps, 9.6Kbps, 19.2Kbps, 38.4Kbps.	
		 	Parity setting Range : odd, even, non.	
		 	Duration (communication, alarm trigger delay) for communication loss detection. Displays alarm when no new communication data is received for the duration. If "oFF" is selected, no monitoring for communication channel is activated. Setting range : 1~999 sec, oFF	
33	Test trip		When this menu activated, OL trip signal and enabled short or EF trip signal is generated when (3s+ot) expires. The display shows "End" when the test is done. By pressing ESC, returns to the load current display mode. This menu is not displayed when the motor is starting or running. Before (3s+ot) expires, pressing ESC or motor starting or running blocks the test trip and return to the load current display. No parameter	No parameter
34	End		This shows the end of test trip. Test result is stored in the fault record.	No parameter

* #1 => These are applied to i3MZ & iFMZ only.
 #2 => These are applied to i3MS & iFMS only.
 #3 => This is applied to i3M420 & iFM420 only.
 #4 => This is applied to i3DM & iFDM only.

* Menus from password to reversed phase detection are not displayed during the motor running.

EOCR-i Series (with communication)

Basic model : EOCR-i3DM (Z, S, 420) / iFDM (Z, S, 420)

Alert operation pattern (i3DM & iFDM only)

ALo Selection \ Running Stage	Starting	Norma Operation	Higher than the preset Alert value	Trip
Aux (ALo: A)	[Pattern]	[Pattern]	[Pattern]	[Pattern]
Flicker (ALo: F)	[Pattern]	[Pattern]	[Pattern]	[Pattern]
Hold (ALo: H)	[Pattern]	[Pattern]	[Pattern]	[Pattern]

- ALo "A" : Ampere relay function (The 07-08 output contact is closed when a current is detected)
- ALo "F" : Flickering (When a current flows, the output contact is closed and repeating the close and open on it in a higher current than the AL setting.)
- ALo "H" : Holding (The output contact is closed in a higher current than the AL setting).
- ALo "uc" : Applied to "uc" (under current protection) output contact.
- ALo "to" : When a running hour time is elapsed over the "rh" set value, the output contact repeats the close - open.

Fail-safe operation

Fail-Safe	A1-A2 not powered	A1-A2 powered and under normal operation	A1-A2 powered and Tripped
ON	95 96 Close 97 98 Open	95 96 Open 97 98 Close	95 96 Close 97 98 Open
OFF	95 96 Close 97 98 Open	95 96 Close 97 98 Open	95 96 Open 97 98 Close

Trip cause indication and fault records

3 fault records including the trip cause and 3phase currents are stored in a non-volatile memory.

When the motor is running or stopped, trip cause can be navigated by pressing ESC button over 5seconds

Trip indication					
Trip cause	Trip		Indication after trip with UP/ DN button pressing		
	Indication	Contents of indication	L1 LED on	L2 LED on	L3 LED on
Over current		OC Trip caused by r(L1)-phase current			
Phase loss		Phase Loss caused by r(L1)-phase lost			
Reversed phase		Phase reversal trip			
Stall		Stall trip during motor starting caused by s(L2)-phase current			
Jam		Jam trip during motor running caused by t(L3)-phase current			
Imbalance		Imbalance trip caused by t(L3)-phase current			
Under current		Under current trip caused by s(L2)-phase current			
Earth fault (i3MZ/iFMZ)		Earth fault(Earth leakage) trip with Earth fault current indication			
Short circuit (i3MS/iFMS)		Short Circuit trip caused by s(L2)-phase current			
Limitation of auto-restart		In 30minutes, the number of auto-restart by auto-reset exceeds the setting	For emergency restart, manual reset by pressing ESC clears the restart counter to zero.		

EOCR-i Series (with communication)

Basic model : EOCR-i3DM (Z, S, 420) / iFDM (Z, S, 420)

Time-current characteristic curve

Inverse characteristic

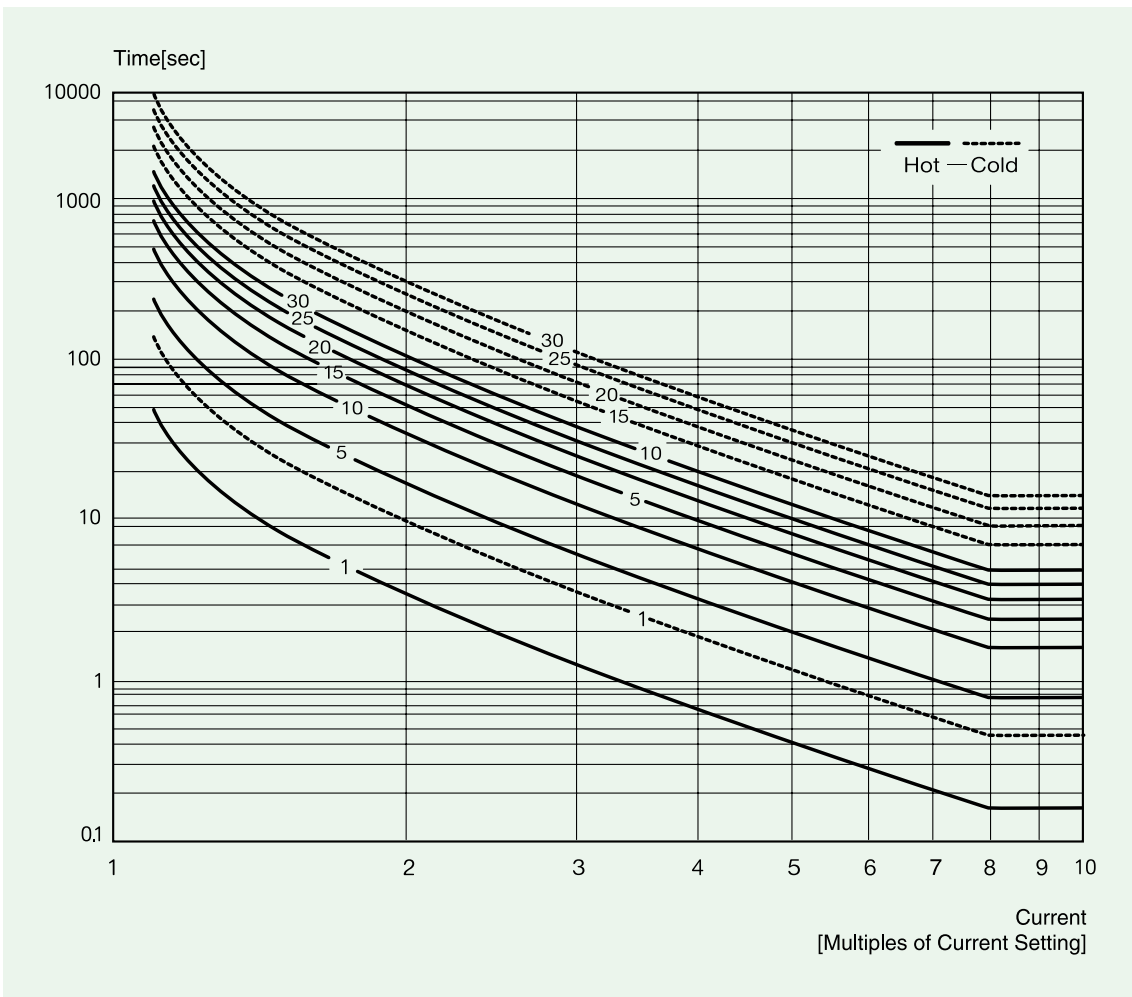

Definite characteristic

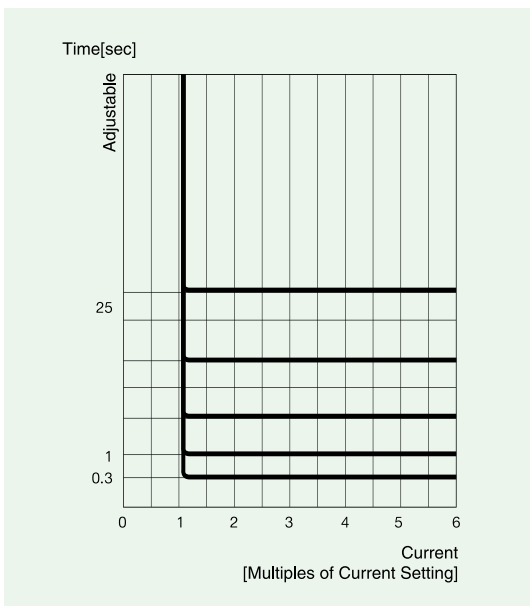

Thermal inverse characteristic

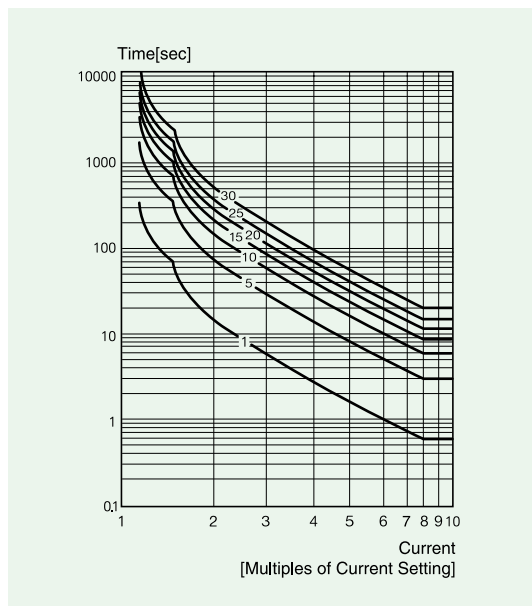

EOCR-i Series (with communication)

Basic model : EOCR-i3DM (Z, S, 420) / iFDM (Z, S, 420)

Current setting range

Setting range	Number of pass through the CT hole	External CT ratio	CT setting	Remark
0.5 ~ 60A	1	No CT combination		
0.25 ~ 3A	2	No CT combination		
0.1 ~ 1.2A	5	No CT combination		
0.5 ~ 32A	1	No CT combination		Inverse TCC or thermal Inverse TCC
0.5 ~ 60A	1	No CT combination		Definite TCC
10 ~ 100A	1	100 : 5		Definite or inverse (th)
20 ~ 200A	1	200 : 5		Definite or inverse (th)
30 ~ 300A	1	300 : 5		Definite or inverse (th)
40 ~ 400A	1	400 : 5		Definite or inverse (th)
50 ~ 500A	1	500 : 5		Definite or inverse (th)
60 ~ 600A	1	600 : 5		Definite or inverse (th)
70 ~ 700A	1	700 : 5		Definite or inverse (th)
80 ~ 800A	1	800 : 5		Definite or inverse (th)

Typical wiring schematic

Typical wiring for EOCR-i3DM / iFDM (3 phase motor - window type)

Single phase motor (window type)

Bottomhole type

EOCR-i Series (with communication)

Basic model : EOCR-i3DM (Z, S, 420) / iFDM (Z, S, 420)

Typical wiring schematic

Typical wiring for EOCR-i3MZ / iFMZ

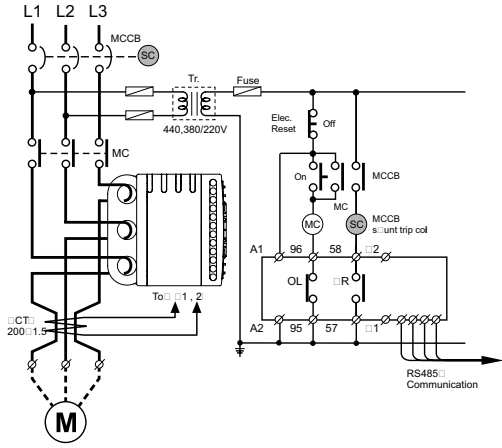

Typical wiring for EOCR-i3MS / iFMS

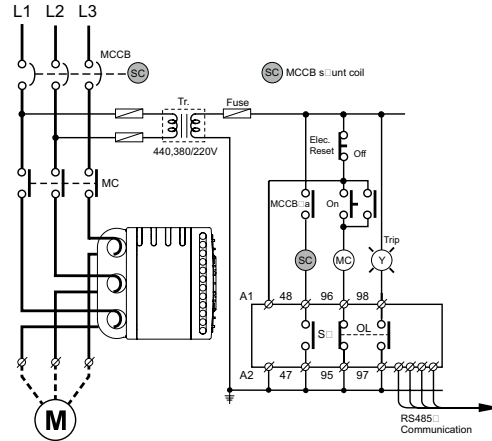

Typical wiring for EOCR-i3M420 / iFM420

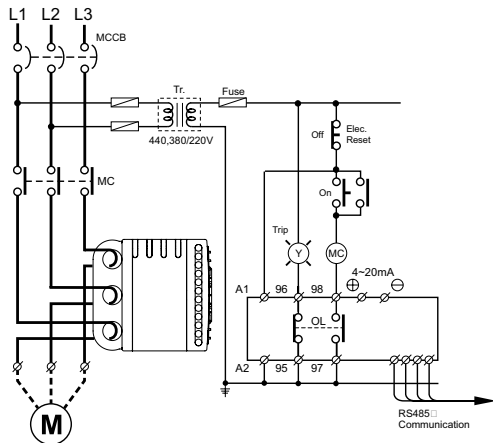

Cabling for a three phase motor



Cabling for a single phase motor



EOCR-i Series (with communication)

Basic model : EOCR-i3DM (Z, S, 420) / iFDM (Z, S, 420)



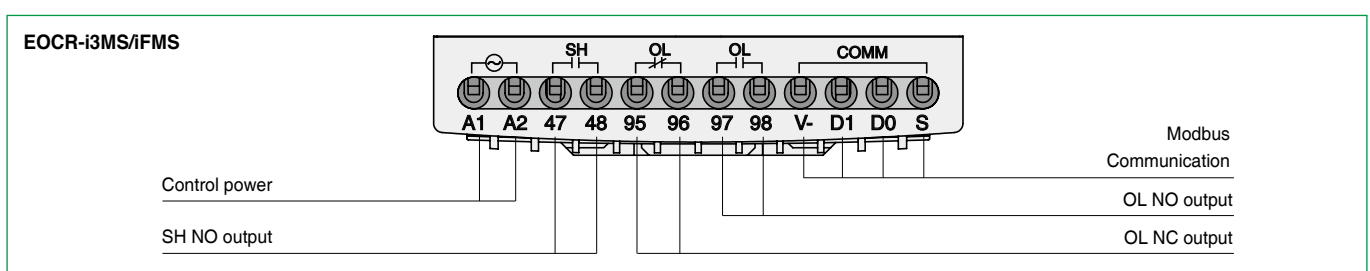
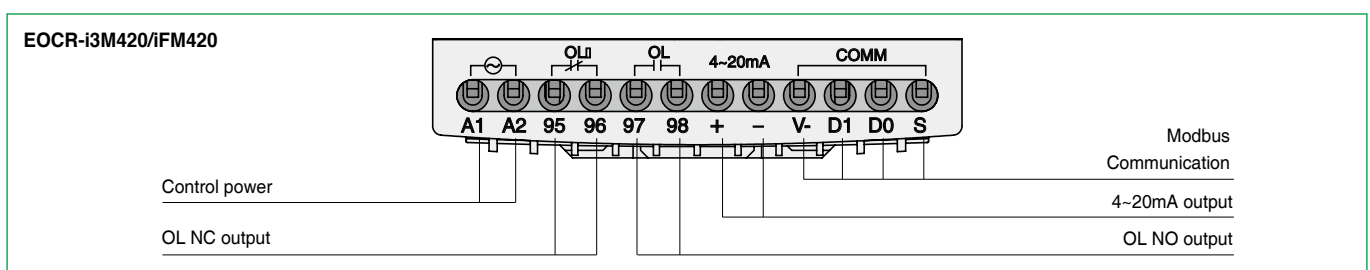
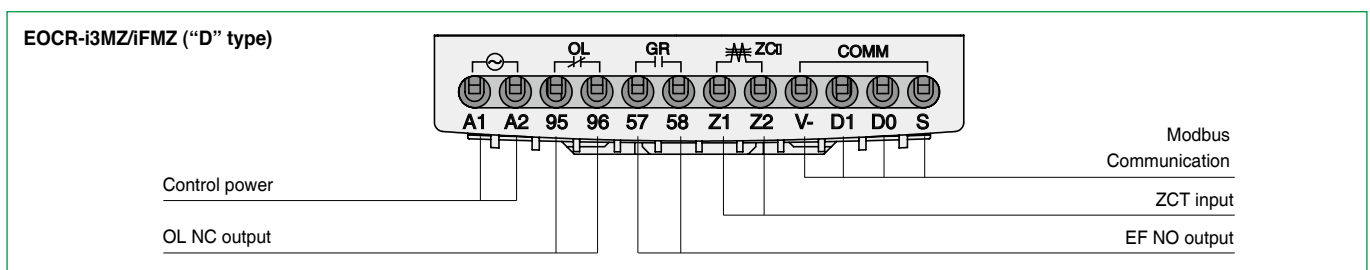
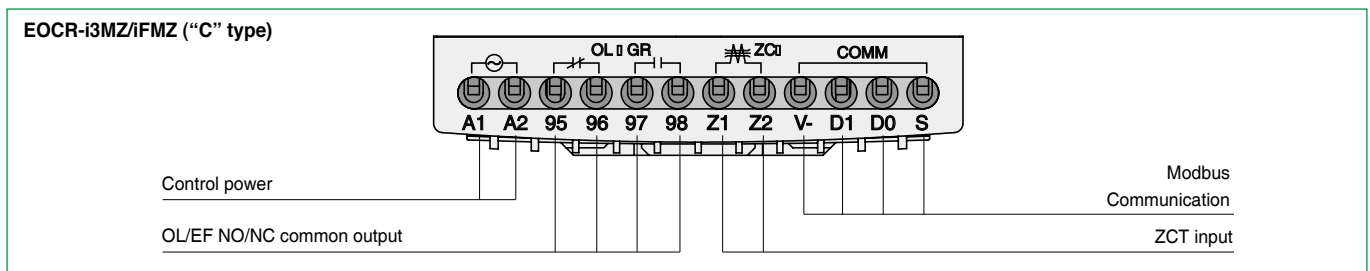
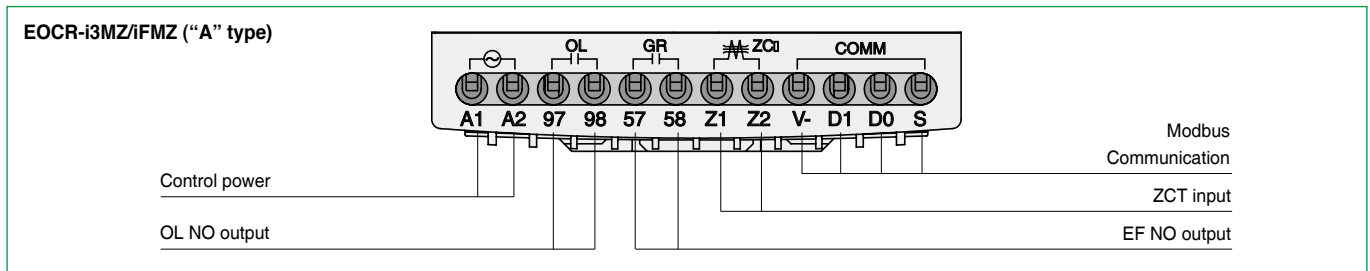
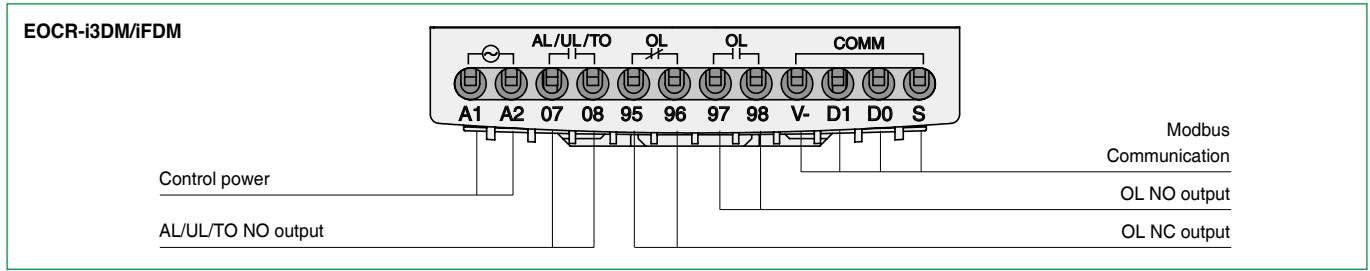

Control terminals

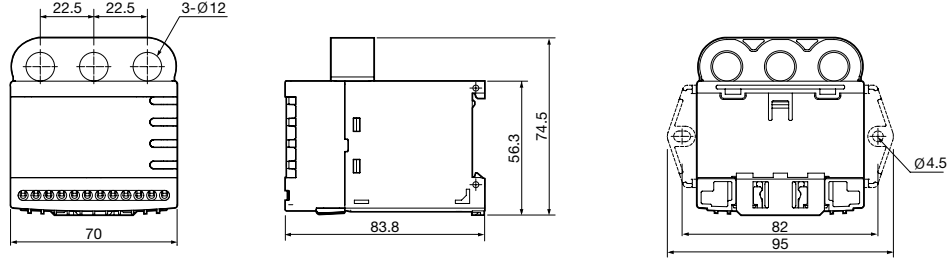

EOCR-i Series (with communication)

Basic model : EOCR-i3DM (Z, S, 420) / iFDM (Z, S, 420)

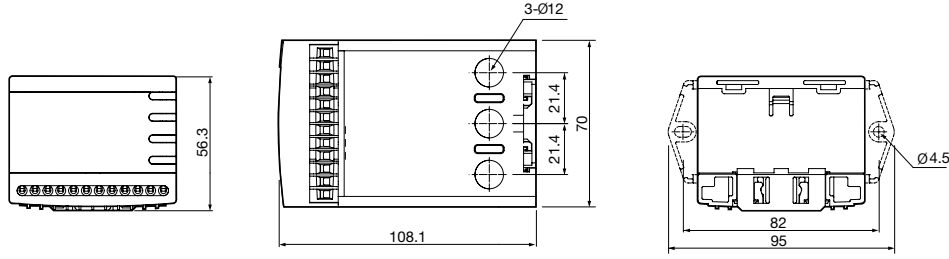

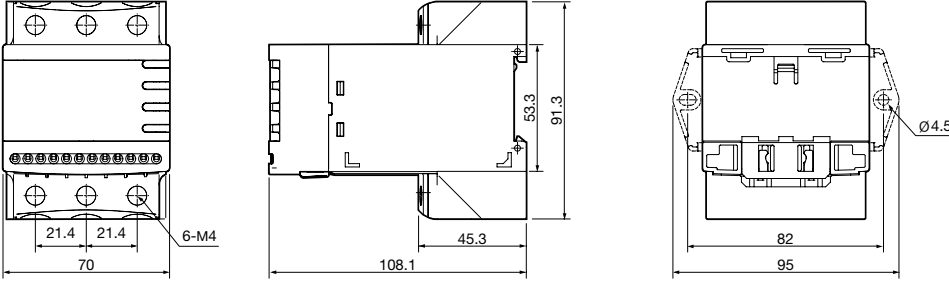



Dimension of i3XX

<p>Window type EOCR-i3DM EOCR-i3M420 EOCR-i3MZ EOCR-i3MS</p> 	 <p>PANEL & DIN RAIL TYPE</p> <p>MOUNTING HOLE SIZE</p>
<p>Bottom hole type EOCR-i3DM EOCR-i3M420 EOCR-i3MZ EOCR-i3MS</p> 	 <p>PANEL & DIN RAIL TYPE</p> <p>MOUNTING HOLE SIZE</p>
<p>Terminal type EOCR-i3DM EOCR-i3M420 EOCR-i3MZ EOCR-i3MS</p> 	 <p>PANEL & DIN RAIL TYPE</p> <p>MOUNTING HOLE SIZE</p>

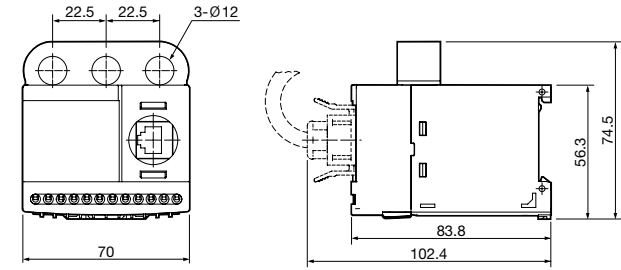
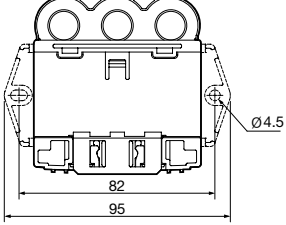
EOCR-i Series (with communication)

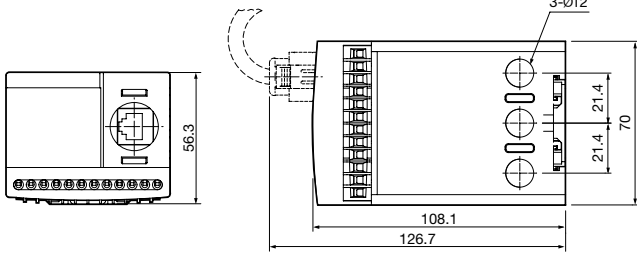
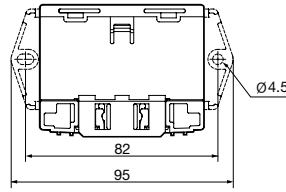
Basic model : EOCR-i3DM (Z, S, 420) / iFDM (Z, S, 420)

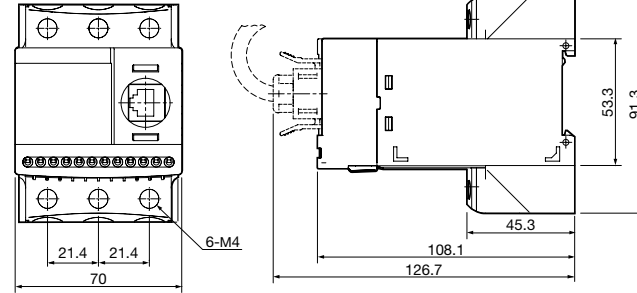
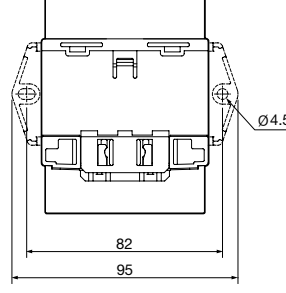
Dimension of iFXX

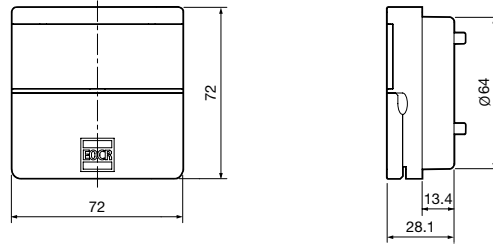
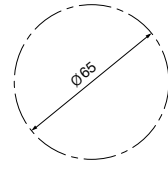
<p>Window type EOCR-iFDM EOCR-iFMZ</p> <p>EOCR-iFM420 EOCR-iFMS</p> 	 <p>PANEL & DIN RAIL TYPE</p>	 <p>MOUNTING HOLE SIZE</p>
<p>Bottom hole type EOCR-iFDM EOCR-iFMZ</p> <p>EOCR-iFM420 EOCR-iFMS</p> 	 <p>PANEL & DIN RAIL TYPE</p>	 <p>MOUNTING HOLE SIZE</p>
<p>Terminal type EOCR-iFDM EOCR-iFMZ</p> <p>EOCR-iFM420 EOCR-iFMS</p> 	 <p>PANEL & DIN RAIL TYPE</p>	 <p>MOUNTING HOLE SIZE</p>
<p>Display EOCR-PDM</p> 	 <p>MOUNTING HOLE SIZE</p> 	

EOCR-i Series (with communication)

Basic model : EOCR-i3DM (Z, S, 420) / iFDM (Z, S, 420)

Ordering

EOCR-i3XX



Window CT



Bottom CT



Terminal



External CT combination type

		①	②	③	④	⑤	⑥
①	Model name	i3DM	Basic model				
		i3MZ	GF model				
		i3M420	4~20mA output model				
		i3MS	SC model				
②	Current Range	WR	0.5~60A 0.5~20A (i3MS)				
		H1	100:5 3CT combination type				
		HH	150:5 3CT combination type				
		H2	200:5 3CT combination type				
		H3	300:5 3CT combination type				
		H4	400:5 3CT combination type				
③	Output contact type	i3MZ	A	a(97-98) :OC, a(57-58) : GR			
			C	b(95-96), a(97-98) : OC.GR common			
			D	b(95-96) :OC, a(57-58) : GR			
		D	b(95-96), a(97-98)				
④	Control voltage	B	24VAC/DC				
		U	100~240VAC/DC				
		W	Window type				
⑤	CT type	H	Bottom hole type				
		T	Terminal type				
		Q					
⑥	Export code						

EOCR-iFX



Window CT



Bottom CT



Terminal



External CT combination type

		①	②	③	④	⑤	⑥
①	Model name	i3DM	Basic model				
		i3MZ	GF model				
		i3M420	4~20mA output model				
		i3MS	SC model				
②	Current Range	WR	0.5~60A 0.5~20A (iFMS)				
		H1	100:5 3CT combination type				
		HH	150:5 3CT combination type				
		H2	200:5 3CT combination type				
		H3	300:5 3CT combination type				
		H4	400:5 3CT combination type				
③	Output contact type	i3MZ	A	a(97-98) :OC, a(57-58) : GR			
			C	b(95-96), a(97-98) : OC.GR common			
			D	b(95-96) :OC, a(57-58) : GR			
		D	b(95-96), a(97-98)				
④	Control voltage	B	24VAC/DC				
		U	100~240VAC/DC				
		W	Window type				
⑤	CT type	H	Bottom hole type				
		T	Terminal type				
		Q					
⑥	Export code						